

SPINNING REEL — J1650X/2050X

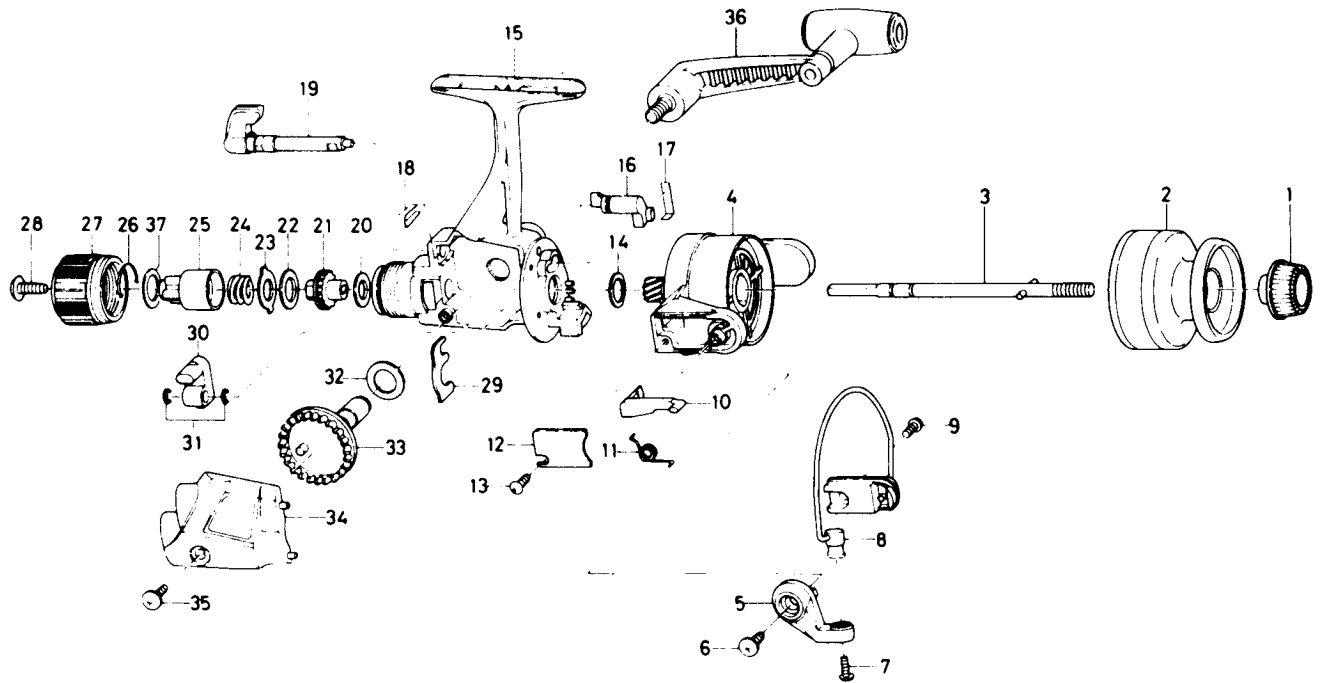

Key No.	Parts No.	Parts Name
1	L07-7301	Spool cap
2	L07-8301	Spool assembly
3	L08-1101	Main shaft assembly
4	L07-9101	Rotor assembly
5	L50-1301	Bail arm
6	L00-2602	Bail arm screw
7	B67-9301	Line roller screw
8	L07-9601	Bail
9	L01-1702	Bail trip cam screw
10	L07-9401	Bail trip lever
11	B91-6501	Bail spring
12	L07-9501	Bail spring cover
13	L01-1702	Bail spring cover screw
14	372-8600	Rotor washer
15	L07-8701	Body
16	L07-9001	Anti-reverse pawl
17	L08-5901	Anti-reverse pawl spring
18	L07-4101	Anti-reverse cam spring
19	L07-8901	Anti-reverse lever
20	B46-9505	Drag washer A
21	L08-1401	Click gear
22	B78-6602	Drag washer B

Key No.	Parts No.	Parts Name
23	B83-9501	Eared washer
24	B92-6703	Drag coil spring
25	L08-1301	Drag screw
26	L08-0701	Drag washer spring
27	L08-0801	Drag knob
28	E00-7601	Drag knob screw
29	L08-1501	Pinion retainer
30	L08-1001	Oscillating slider
31	320-8202	Oscillating slider retainer
32	370-7500	Drive gear washer
33	L07-9801	Drive gear
34	L08-0301	Side cover
35	E00-7101	Side cover screw
36	L50-2901	Handle assembly
37	L11-0101	Drag screw washer

J2050X Special Parts

2	L08-0001	Spool assembly
4	L08-2001	Rotor assembly
8	L08-1601	Bail
10	L08-2201	Bail trip lever
34	L08-0302	Side cover