

FLY REEL 734

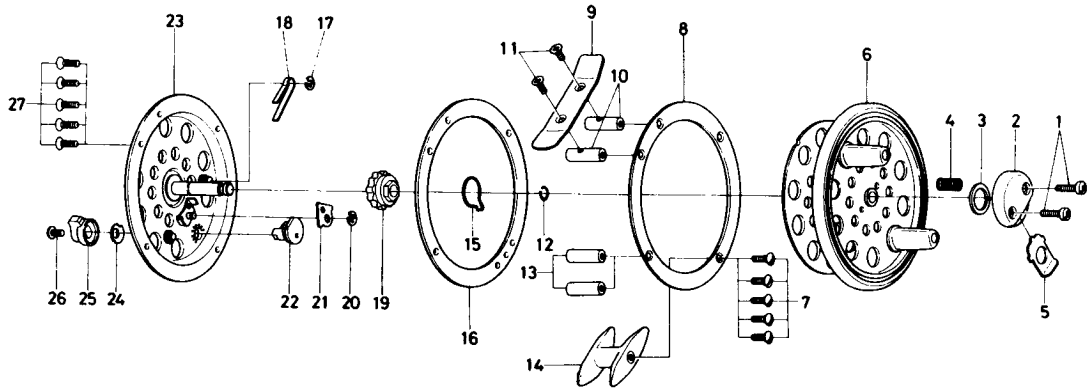

LINE CAPACITY: Upto and including AFTMA 9

Key No. 1 ~ 6

6-731-8801 Spool assembly \$12.50

Key No.	Parts No.	Parts Name	Price Per Piece	Key No.	Parts No.	Parts Name	Price Per Piece
1	6-353-0001	Cover screw	\$.10	15	6-144-2901	Friction spring	\$.15
2	6-130-4701	Cover	.20	16	6-171-1701	Body ring	3.30
3	6-375-3801	Cover washer	.10	17	6-320-7601	Click spring retainer	.10
4	6-144-1801	Spool stopper spring	.10	18	6-151-5701	Click spring	.40
5	6-541-3401	Spool stopper	.40	19	6-750-4101	Click gear	.90
6	6-731-8901	Spool	N/A	20	6-320-5901	Click claw retainer	.10
7	6-353-3501	Screw	.15	21	6-030-5201	Click claw	.30
8	6-560-3801	Ring	4.25	22	6-461-3801	Cam	.60
9	6-610-3401	Stand	2.30	23	6-706-2201	Body	8.25
10	6-050-6401	Stand pillar	.65	24	6-151-5301	Click lever washer	.10
11	6-353-3601	Stand screw	.10	25	6-541-3501	Click lever	.15
12	6-320-8901	Click gear retainer	.10	26	6-352-2501	Click lever screw	.10
13	6-050-6501	Pillar	.65	27	6-353-3501	Screw	.15
14	6-310-1201	Line guard	1.35				