

835 RT

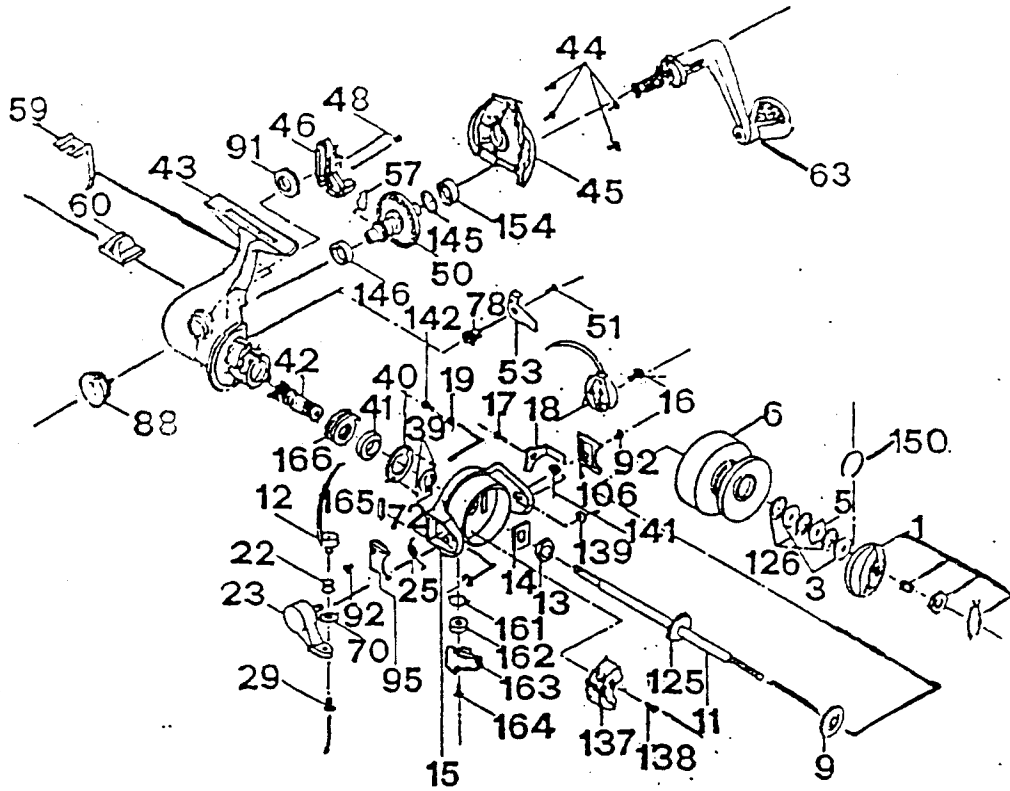

REF #	PART NUMBER	DESCRIPTION	REF #	PART NUMBER	DESCRIPTION
1	79-40-0193-01	DRAG BUTTON	3	79-72-0640-01	KEYED WASHER
5	79-72-0641-01	EARED DRAG WASHER	6	835 001	SPOOL
9	79-72-0624-01	MAIN SHAFT WASHER	11	79-60-0138-01	MAIN SHAFT
12	79-03-0111-01	BAIL WIRE	13	79-40-0182-01	PICK UP HOUSING NUT
14	79-72-0635-01	PICK UP HOUSING WASHER	15	79-34-0144-01	PICK UP HOUSING
16	79-71-0004-01	BRACKET STUD	17	79-58-0609-01	TRIP LEVER SCREW
18	79-37-0188-01	TRIP LEVER	19	79-67-0635-01	TRIP LEVER SPRING
22	79-57-0045-01	LINE ROLLER	23	79-07-0080-01	BAIL BRACKET
25	79-67-0630-01	TRIP SPRING	29	79-58-0596-01	LINE ROLLER SCREW
39	79-58-0626-01	BALL RACE RETAINER SCREW	40	79-53-0061-01	BALL RACE RETAINER
41	79-04-0066-01	BALL RACE	42	79-46-0100-01	PINION
43	79-27-0173-01	FRAME	44	79-58-0610-01	COVER PLATE SCREW
45	79-47-0382-01	COVER PLATE	46	79-07-0081-01	LEVER WIND BRACKET
48	79-58-0611-01	HOLDER SCREW	50	79-28-0176-01	DRIVE GEAR
51	79-58-0609-01	NON REVERSE PAWL SCREW	53	79-43-0123-01	NON REVERSE PAWL
57	79-67-0631-01	NON REVERSE PAWL SPRING	59	79-67-0634-01	PUSH BUTTON SPRING
60	79-10-0079-01	PUSH BUTTON	63	79-20-0147-01	HANDLE
70	79-72-0644-01	LINE ROLLER WASHER	72	79-65-0026-01	SPACER
78	79-72-0643-01	NON REVERSE PAWL WASHER	88	79-12-0055-01	DUST CAP
91	79-28-0175-01	LEVER WIND GEAR	92	79-58-0612-01	BRACKET COVER SCREW
95	79-47-0384-01	BRACKET COVER	106	79-19-0103-01	DRAG COVER
125	79-50-0057-01	CLICK RATCHET	126	79-72-0646-01	DRAG WASHER
37		COUNTER WEIGHT	138		COUNTER WEIGHT SCREW
39	79-15-0019-01	C CLIP	141	79-72-0642-01	TRIP LEVER WASHER
142	79-58-0614-01	TRIP LEVER SPRING	145	79-72-0647-01	DRIVE GEAR WASHER
146	79-09-0030-01	DRIVE GEAR BUSHING	150	79-67-0632-01	WIRE SPRING
154	79-09-0033-01	DRIVE GEAR BUSHING	161	79-67-0633-01	TRIGGER SPRING
162	79-72-0648-01	TRIGGER WASHER	163	79-37-0194-01	TRIGGER
164	79-58-0615-01	TRIGGER SCREW	166	79-50-0058-01	N/R RATCHET
167	79-71-0005-01	BRACKET STUD			