

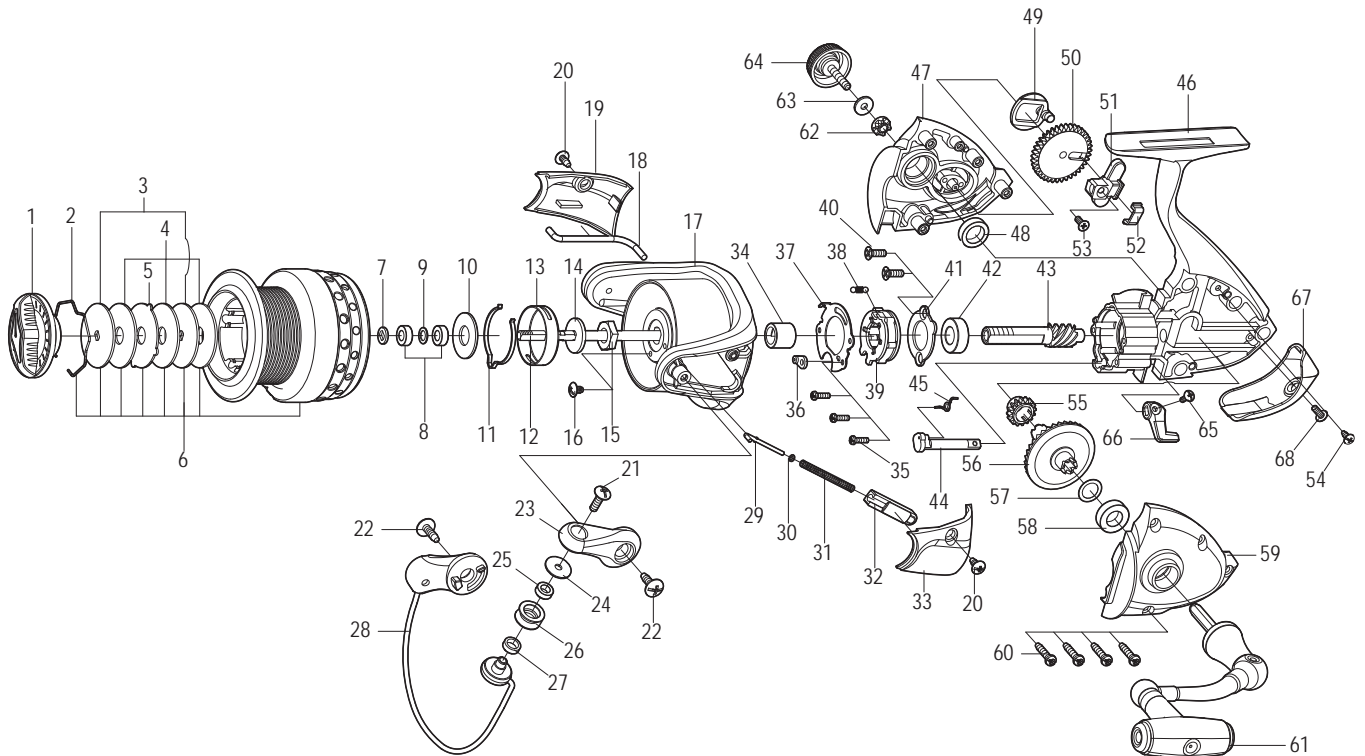

SPINNING REEL

DYNASPIN

SH3000 / SH3500



Key NO.	Parts No.	Parts name	Key NO.	Parts No.	Parts name
1	2YD-089-05	DRAG KNOB ASSEMBLY	36	2F8-079-01	ANTI-REVERSE SPRING ANCHOR
2	2E4-034-01	DRAG WASHER RETAINER	37	2F5-192-01	ROLLER CLUTCH RETAINER
3	2W2-071-01	KEY WASHER	38	2Q2-016-01	SPRING
4	2W1-226-01	080-260 WASHER	39	2YZ-014-01	ONE-WAY CLUTCH BEARING ASSEMBLY
5	2W3-035-01	EARED WASHER	40	2E2-052-01	F26M-080 SCREW
6	2YT-415-05	SPOOL TOTAL ASSEMBLY	41	2F5-193-01	BEARING RETAINER
7	2W2-016-01	KEY WASHER	42	2Z1-003-05	714-5 BALL BEARING
8	2Z1-029-05	408-3 BALL BEARING	43	2G2-155-01	PINION GEAR
9	2C1-119-01	SPACER	44	2A2-031-01	ANTI-REVERSE CAM
10	2W1-053-01	080-185 WASHER	45	2Q3-009-01	ANTI-REVERSE SPRING
11	2L3-015-01	CLICK LEAF SPRING	46	2YB-206-06	BODY ASSEMBLY
12	2M3-120-01	MAIN SHAFT	47	2B2-110-07	BODY CAVER(R)
13	2F8-019-02	CLICK LEAF SPRING HOLDER	48	2Z1-010-05	812-3.5 BALL BEARING
14	2W2-015-01	KEY WASHER	49	2M2-016-01	OSCILLATING CAM
15	2E3-007-01	ROTOR NUT	50	2G3-081-01	OSCILLATING GEAR
16	2E1-036-01	B26-040 SCREW	51	2M1-057-01	OSCILLATING SILDER
17	2R1-137-04	ROTOR	52	2E5-051-01	OSCILLATING SILDER RETAINER
18	2R5-164-01	BAIL PAWL	53	2E2-009-02	F23M-060 SCREW
19	2R4-185-01	BAIL TRIP COVER	54	2E1-020-02	B22-055 SCREW
20	2E1-015-02	B26-060 SCREW	55	2G3-068-01	DRIVE PINION
21	2E2-007-01	B30M-100 SCREW	56	2G1-141-01	DRIVE GEAR
22	2E1-010-01	b30-100 SCREW	57	2W1-019-00	071-103 WASHER
23	2R2-062-04	BAIL ARM	58	2Z1-039-05	713-4 BALL BEARING
24	2C1-034-01	LINE ROLLER COLLAR	59	2B2-111-07	BODY CAVER(L)
25	2Z1-012-05	407-2.5 BALL BEARING	60	2E1-005-02	A26-120 SCREW
26	2R6-020-02	LINE ROLLER	61	2YH-359-01	HANDLE TOTAL ASSEMBLY
27	2C2-032-01	LINE ROLLER BUSH	62	2C3-042-01	HANDLE SCREW SLEEVE
28	2YL-146-05	BAIL ASSEMBLY	63	2W1-004-01	029-080 WASHER
29	2R5-135-01	BAIL TRIP SHAFT	64	2H6-017-02	HANDLE SCREW CAP
30	2W1-199-01	015-027 WASHER	65	2E2-013-02	B20M-060 SCREW
31	2Q1-096-01	BAIL SPRING	66	2A1-033-05	ANTI-REVERSE LEVER
32	2C2-119-01	BAIL SPRING GUIDE	67	2F5-389-04	REAR COVER
33	2R4-184-01	BAIL SPRING COVER	68	2E2-051-01	B23M-060 SCREW
34	2A4-021-01	ONE-WAY CLUTCH INNER TUBE	SH3500	SPECIAL PARTS	
35	2E2-047-02	A20M-065 SCREW	6	2YT-437-05	SPOOL TOTAL ASSEMBLY