

QUANTUM

CABO

CBC31PTS

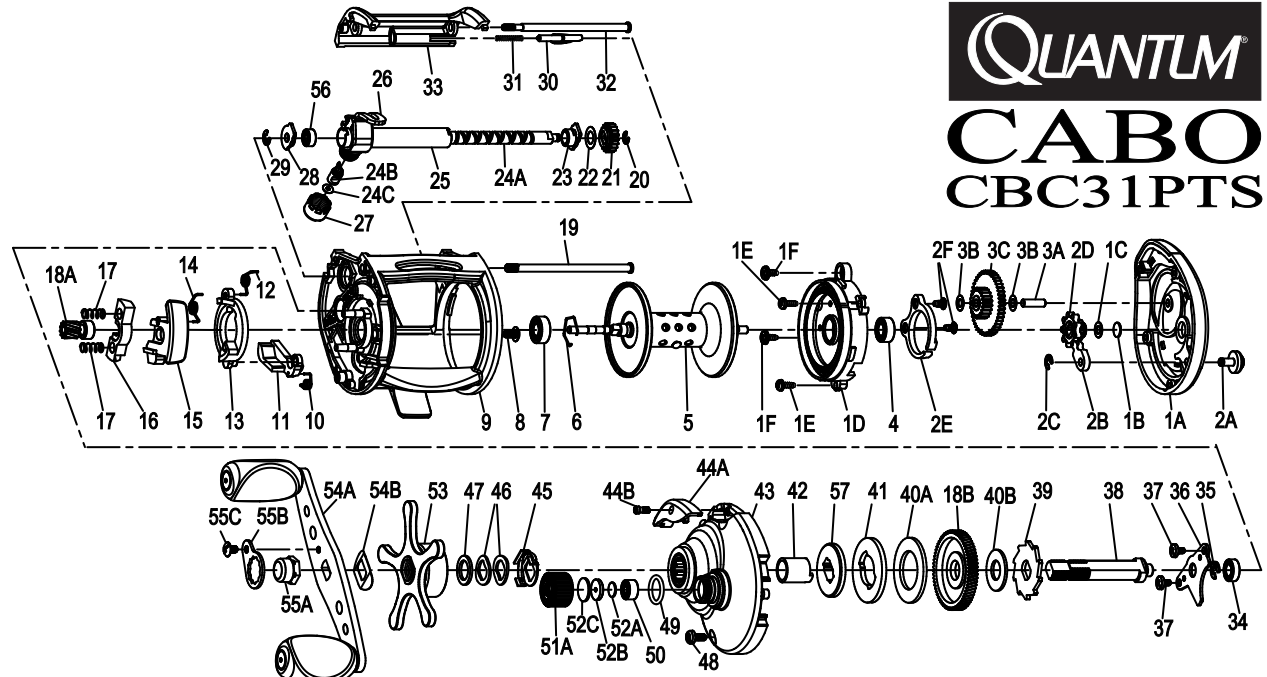

Key #	Description	Part No.
1	Palm Side Cover Kit includes: 1A - Palm Side Cover Assembly 1B - Spool Shaft Washer 1C - O/S Drive Gear Washer 1D - Spool Cover Assembly 1E - Spool Cover Screw "B" 1F - Spool Cover Screw "A" 2 - Bait Clicker Spring Kit 3 - Idle Gear Kit 4 - Palm Side Spool Shaft Bearing	QX4023-02
2	Bait Clicker Spring Kit includes: 2A - Bait Click Lever 2B - Bait Click Pawl 2C - E-Clip 2D - O/S Drive Gear 2E - Bait Clicker Spring 2F - Bait Clicker Spring Screw	QX4109-01
3	Idle Gear Kit includes: 3A - Idle Gear Post 3B - Idle Gear Washer 3C - Idle Gear	PX4127-01
4	Palm Side Spool Shaft Bearing	JX106-01
5	Spool Assembly	QX321-02
6	Clip Ring	EX080-01
7	Gear Side Spool Shaft Bearing	EX017-02
8	Gear Side Cover Screw -A	QW123-01
9	Frame	QX001-02
10	Kick Lever Spring	MX097-01
11	Kick Lever	MX077-01
12	Release Slider Spring	MX104-01
13	Release Slider	MX039-01
14	Push Button Spring	MX089-01
15	Push Button	MX062-01
16	Pinion Yoke	MX025-01
17	Yoke Spring	GX040-01
18	Gear Kit includes: 18A - Pinion Gear Assembly 18B - Drive Gear	MX4011-02
19	Stabilizer Bar - "B"	QX061-01
20	E-Clip	NX090-01
21	O/S Pinion Gear	HV085-01
22	Worm Shaft Washer	EX035-01
23	Palm Side Worm Shaft Bushing	PX088-01
24	Worm Shaft Kit Includes: 24A - Worm Shaft 24B - Line Guide Pawl 24C - Carrier Washer	PX4072-02
25	Worm Shaft Guide	PX016-01

Key #	Description	Part No.
26	Line Guide Carrier	GX047-02
27	Line Guide Carrier Screw	ZW007-02
28	Worm Shaft Bearing Retainer	HX067-01
29	E-Clip	NX092-01
30	Palm Side Cover Locking Lever	MX119-01
31	Palm Side Cover Locking Spring	ZW096-01
32	Stabilizer Bar - "A"	PX061-01
33	Front Support	QX099-02
34	Crank Shaft Bearing - Lower	SW017-01
35	E-Clip	QW120-01
36	Crank Shaft Retainer	GX002-01
37	Crank Shaft Retainer Screw	JX107-01
38	Crank Shaft	MX008-02
39	Trip Ratchet	EX083-01
40	Drag Disc Kit includes: 40A - Drag Disc 40B - Trip Ratchet Washer	HV4059-01
41	Drag Key Washer	MX045-01
42	One Way Bearing Sleeve	HV052-01
43	Gear Side Cover Assembly	MX324-04
44	Oil Port Cap Kit includes: 44A - Oil Port Cap 44B - Oil Port Cap Screw	MX4150-02
45	Drag Click Spring Assembly	GX4114
46	Spring "D" Washer	JX046-01
47	Star Drag Washer	ZW032-02
48	Gear Side Cover Screw - B	GX107-01
49	Tension Knob O-Ring	QW101-01
50	Tension Knob Bearing	SW117-01
51	Tension Knob Kit includes: 51A - Spool Tension Knob Assembly 52 - Spool Tension Washer Kit	CX4033-02
52	Spool Tension Washer Kit Includes: 52A - Spool Tension Washer 52B - Spool Tension Collar 52C - Spool Cushion Washer	QW4032-01
53	Star Drag Assembly	MX355-02
54	Handle Kit includes: 54A - Handle Assembly 54B - Handle Washer 55 - Handle Nut Kit	PX4018-02
55	Handle Nut Kit includes: 55A - Handle Nut 55B - Handle Nut Retainer 55C - Handle Nut Retainer Screw	MX4003-02
56	Worm Shaft Ball Bearing	XX117-01
57	Drag Link	GX036-01